

M1 Series

1W Semi-regulated Single & Dual output

Features

- 7 Pin SIL Package
- Semi-regulated output
- 1000 VDC Isolation
- Up to 3000 VDC Isolation
- Low Ripple and Noise
- Efficiency up to 89%
- -40 ~ 85°C Operation Temperature Range
- Non-Conductive Black Plastic Case

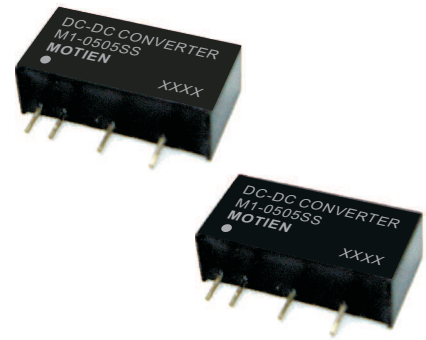

The M1 series is a family of cost effective 1W single & dual output DC-DC converters. These converters achieve low cost, high efficiency, semi-regulated and ultra-miniature SIP 7 pin size. Devices are encapsulated using flame retardant resin. The models operate from input voltage of 5, 12, 15, 24, 48 Vdc with output voltage of 5, 9, 12, 15, ±5, ±9, ±12, ±15 Vdc. High efficiency operation and output voltage accuracy of ±3% maximum. Standard features include an input range of ±10% tolerance and low output noise and ripple.

All specifications typical at Ta=25°C, nominal input voltage and full load unless otherwise specified

OUTPUT SPECIFICATIONS	
Voltage accuracy	±3%
Line regulation	±1.2% / Per 1% Vin Change
Load regulation(From 10% to 100% Load)	See table
Ripple & noise (20 MHz bandwidth)(1)	50mV pk-pk
Temperature coefficient	±0.02%/°C
Capacitor load(2)	See table

INPUT SPECIFICATIONS	
Voltage Range	±10%
Max. Input Current	See table
No-Load Input Current	See table
Input Filter	Capacitors
Input Reflected Ripple Current	5V 20mA pk-pk
	12V 20mA pk-pk
	15V 30mA pk-pk
	24V 40mA pk-pk
	48V 50mA pk-pk

GENERAL SPECIFICATIONS	
Efficiency	See table
I/O Isolation Voltage(60 sec)	1000~3000Vdc
Input/Output	60 pF typ.
I/O Isolation Capacitance	1G Ohm
I/O Isolation Resistance	Variable 70kHz
Switching Frequency	95% rel H
Humidity	>2 Mhrs
Reliability Calculated MTBF(MIL-HDBK-217 F)	IEC 60950-1
Safety Standard : (designed to meet)	

EMC SPECIFICATIONS		
Radiated Emissions	EN55032	CLASS B
Conducted Emissions (3)	EN55032	CLASS B
ESD	IEC 61000-4-2	Perf. Criteria A
RS	IEC 61000-4-3	Perf. Criteria A
EFT(4)	IEC 61000-4-4	Perf. Criteria A
CS	IEC 61000-4-6	Perf. Criteria A
PFMF	IEC 61000-4-8	Perf. Criteria A

PHYSICAL SPECIFICATIONS	
Case Material	Non-conductive Black Plastic(UL94V-0 rated)
Pin Material	C5191R-H Solder-coated
Potting Material	Epoxy (UL94V-0 rated)
Weight	
Vin=5V / 12V / 15V / 24V	2.4g, typ.
Vin=48V	2.8g, typ.
Dimensions	
Vin=5V / 12V / 15V / 24V	SIP Case 0.76"x0.24"x0.39"
Vin=48V	SIP Case 0.76"x0.28"x0.39"

ENVIRONMENT SPECIFICATIONS	
Operating Temperature	-40°C~85°C(See Derating Curve)
Maximum Case Temperature	100°C
Storage Temperature	-40°C~125°C
Cooling	Nature Convection

ABSOLUTE MAXIMUM RATINGS(5)	
These are stress ratings. Exposure of devices to any of these conditions may adversely affect long-term reliability.	
Input Surge Voltage(100mS)	
5 Models	9 Vdc, max.
12 Models	18 Vdc, max.
15 Models	20 Vdc, max.
24 Models	30 Vdc, max.
48 Models	54 Vdc, max.
Soldering Temperature	260°C
(1.5mm from case 10 sec.max.)	

M1 - 1W Semi-regulated Single & Dual output

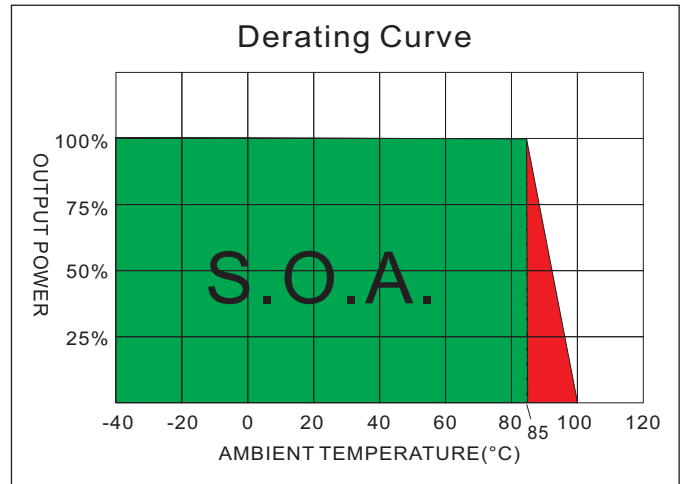
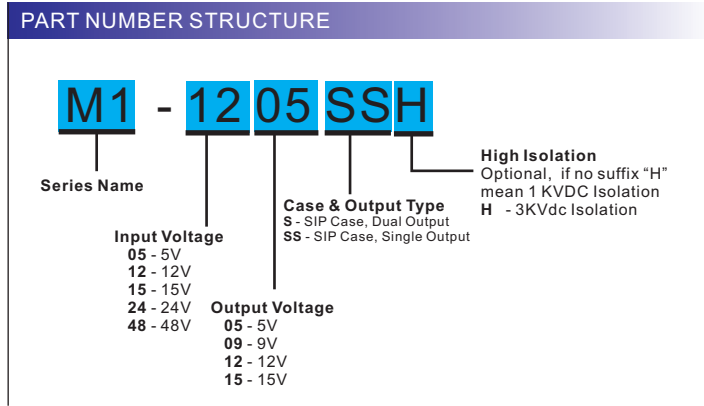

MODEL SELECTION GUIDE

MODEL NUMBER	INPUT Voltage Range (Vdc)	INPUT Current		OUTPUT Voltage (Vdc)	OUTPUT Current Full load (mA)	LOAD Regulation %	EFFICIENCY @FL(%)	Capacitor Load(µF)
		No-Load (mA)	Full Load (mA)					
M1-0505S	5	20	230	±5	±100	6	84	±100
M1-0509S	5	30	230	±9	±55.55	5.5	86	±100
M1-0512S	5	20	228	±12	±41.67	5.5	87	±47
M1-0515S	5	20	228	±15	±33.33	5	87	±47
M1-1205S	12	15	98	±5	±100	4	85	±100
M1-1209S	12	15	95	±9	±55.55	3.5	86	±100
M1-1212S	12	15	94	±12	±41.67	3.5	87	±47
M1-1215S	12	15	94	±15	±33.33	3.5	87	±47
M1-1505S	15	10	78	±5	±100	3.5	85	±100
M1-1509S	15	10	76	±9	±55.55	2.5	87	±100
M1-1512S	15	10	76	±12	±41.67	2.5	87	±47
M1-1515S	15	10	75	±15	±33.33	2.5	88	±47
M1-2405S	24	7	51	±5	±100	3.5	82	±100
M1-2409S	24	7	49	±9	±55.55	2.5	85	±100
M1-2412S	24	7	48	±12	±41.67	2.5	87	±47
M1-2415S	24	7	48	±15	±33.33	2.5	87	±47
M1-4805S	48	5	27	±5	±100	3	77	±100
M1-4809S	48	5	26	±9	±55.55	3	81	±100
M1-4812S	48	5	26	±12	±41.67	3	82	±47
M1-4815S	48	5	26	±15	±33.33	2	81	±47
M1-0505SS	5	20	250	5	200	6	83	220
M1-0509SS	5	20	230	9	111.1	5.5	86	220
M1-0512SS	5	20	230	12	83.3	5.5	87	100
M1-0515SS	5	20	230	15	66.7	5	87	100
M1-1205SS	12	15	98	5	200	4	84	220
M1-1209SS	12	15	96	9	111.1	3.5	86	220
M1-1212SS	12	15	95	12	83.3	3.5	88	100
M1-1215SS	12	15	95	15	66.7	3	88	100
M1-1505SS	15	10	79	5	200	4	84	220
M1-1509SS	15	10	77	9	111.1	3.5	86	220
M1-1512SS	15	10	76	12	83.3	3.5	87	100
M1-1515SS	15	10	76	15	66.7	3	89	100
M1-2405SS	24	7	51	5	200	4	81	220
M1-2409SS	24	7	50	9	111.1	3.5	84	220
M1-2412SS	24	7	49	12	83.3	3.5	85	100
M1-2415SS	24	7	49	15	66.7	2.5	86	100
M1-4805SS	48	5	27	5	200	4	78	220
M1-4809SS	48	5	26	9	111.1	3.5	80	220
M1-4812SS	48	5	26	12	83.3	3	81	100
M1-4815SS	48	5	26	15	66.7	3	81	100

Suffix "H" means 3 K Vdc isolation

The models listed above is just for standard type. If you need the special specification product, please contact our service member by telephone presented in shortform cover or e-mail to : sales@motien.com.tw

NOTE

1. Ripple/Noise measured with 20MHz bandwidth.
2. Tested by minimal V_{in} and constant resistive full load.
3. Input filter components (C1, L, C2, C3) are used to help meet conducted emissions requirement for the module.
These components should be mounted as close as possible to the module; and all leads should be minimized to decrease radiated noise.
4. An external filter capacitor is required if the module has to meet IEC61000-4-4
The filter capacitor Motien suggest: Nippon chemi-con KY series, 220uF/100V.
5. Exceeding the absolute ratings of the unit could cause damage. It is not allowed for continuous operating.
6. Operation under no-load conditions will not damage these devices, however they may not meet all listed specifications.

TEST CONFIGURATIONS

Output Ripple & Noise Measurement Test

The Scope measurement bandwidth is 0-20MHz.

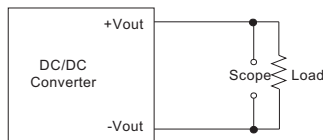

EMI Filter

Input filter components (C1, L, C2, C3) are used to help meet conducted emissions requirement for the module. These components should be mounted as close as possible to the module; and all leads should be minimized to decrease radiated noise.

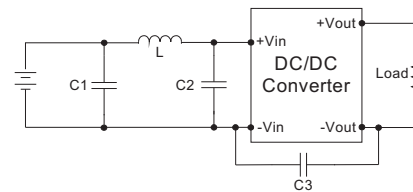

	C1	L	C2	C3
M1-05XXXXX	1210, 2.2uF/100V	18uH		
M1-12XXXXX	1210, 2.2uF/100V	18uH		
M1-15XXXXX	1210, 2.2uF/100V	18uH		
M1-24XXXXX	1210, 2.2uF/100V	18uH	1210, 2.2uF/100V	1206, 470pF/2KV
M1-48XXXXX	1210, 2.2uF/100V	18uH	1210, 2.2uF/100V	1206, 470pF/2KV

ELECTRICAL CHARACTERISTIC CURVES

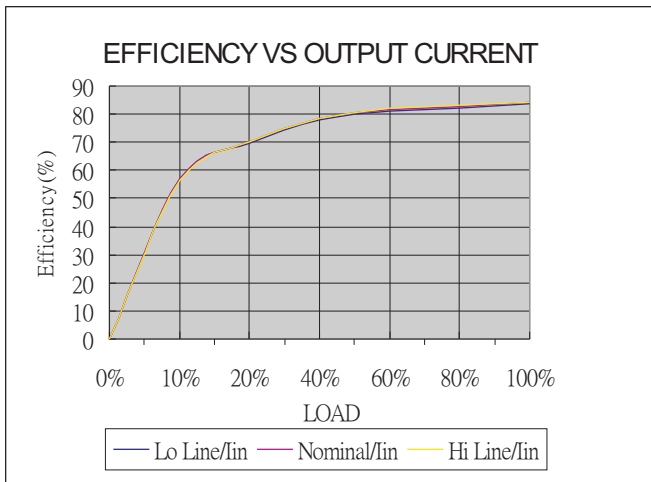

M1-0505SS

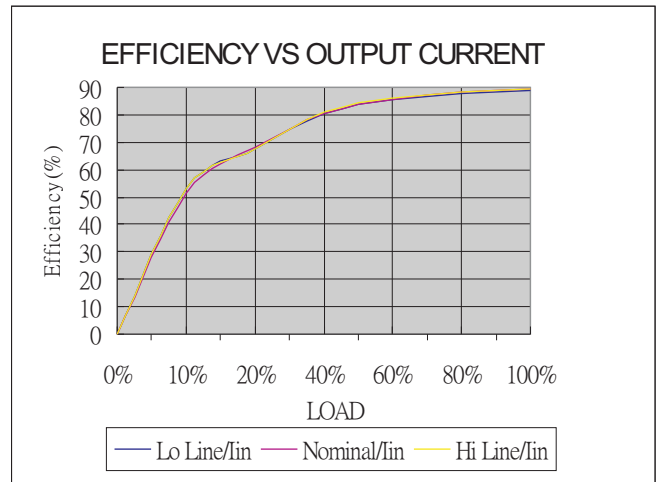

M1-1215S

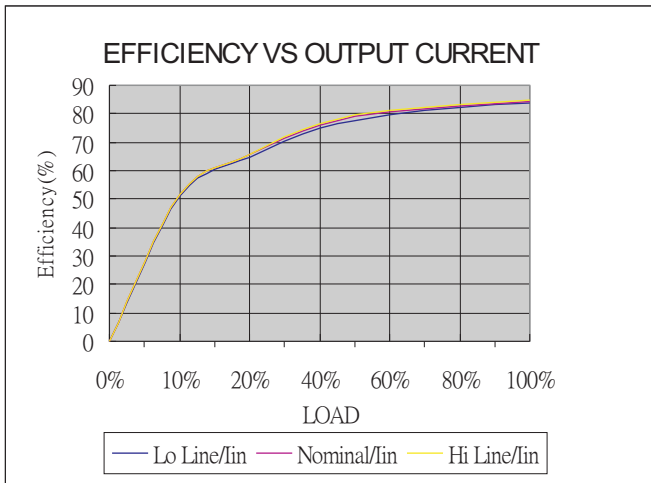

M1-2405SS

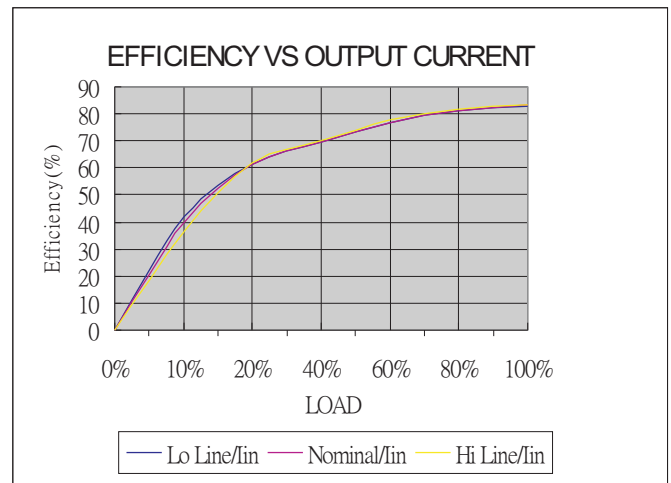

M1-4815S

MECHANICAL SPECIFICATIONS

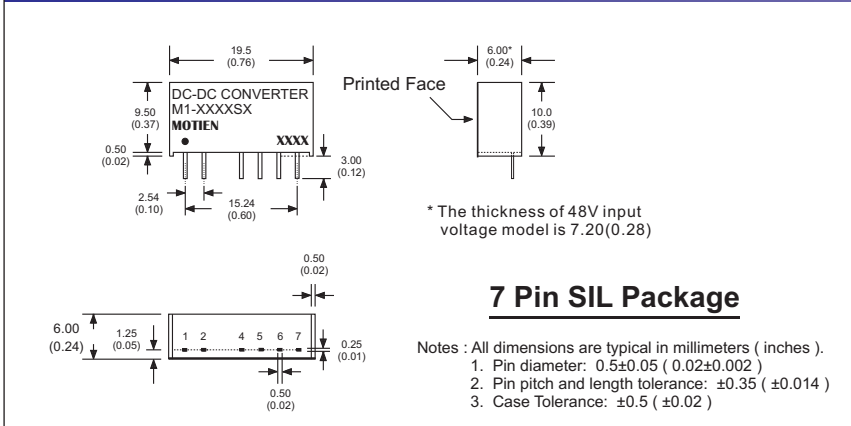

PIN CONNECTIONS				
PIN NUMBER	SINGLE	DUAL	SINGLE-H	DUAL-H
1	+V Input	+V Input	+V Input	+V Input
2	-V Input	-V Input	-V Input	-V Input
4	-V Output	-V Output	N.P.	N.P.
5	N.P.	Common	-V Output	-V Output
6	+V Output	+V Output	N.P.	Common
7	N.P.	N.P.	+V Output	+V Output