

M4-1W Series



1W Regulated Single output

Features

- 7 Pin SIL / 14 Pin DIL Package
- 1000 ~ 3000VDC Isolation
- Continue Short Current Protection
- -40 ~ 85°C Operation Temperature Range
- Non-Conductive Black Plastic Case



The M4 series is a family of cost effective 1W single output DC-DC converters. These converters achieve low cost and ultra-miniature SIP 7 pin or DIP 14 pin size. Devices are encapsulated using flame retardant resin. The models operate from input voltage of 5, 12, 24 Vdc with output voltage of 3.3, 5, 7.2, 9, 12, 15Vdc. Featuring high efficiency up to 69% (input voltage range $\pm 10\%$) and output short circuit protection.

All specifications typical at Ta=25°C, nominal input voltage and full load unless otherwise specified

OUTPUT SPECIFICATIONS	
Output Voltage accuracy	$\pm 2\%$, max.
Line regulation	$\pm 0.5\%$, max.
Load regulation	(From 0% to 100% Load) $\pm 0.5\%$, max. (Output 3.3V Model) $\pm 1.0\%$, max.
Ripple & noise (20 MHz bandwidth)(1)	50mV pk-pk, max.
Temperature coefficient	$\pm 0.02\%/^{\circ}\text{C}$
Short Circuit Protection	Continuous
Capacitor load(2)	See table, max.

INPUT SPECIFICATIONS	
Voltage Range	$\pm 10\%$
Input Current (No Load)	See table, max.
Input Current (Full Load)	See table, typ.
Input Filter	Capacitors
Input Reflected Ripple Current(3)	20mA pk-pk, typ.

ENVIRONMENT SPECIFICATIONS	
Operating Temperature	-40°C~85°C
Maximum Case Temperature	100°C
Storage Temperature	-40°C~125°C
Cooling	Nature Convection

PHYSICAL SPECIFICATIONS	
Case Material	Non-conductive Black Plastic(UL94V-0 rated)
Pin Material	0.5mm Alloy42 Solder-coated
Potting Material	Epoxy (UL94V-0 rated)
Weight	(SIP/2.7g) (DIP/2.7g)
Dimensions	SIP Case 0.76"x0.28"x0.39" DIP Case 0.80"x0.40"x0.27"

EMC SPECIFICATIONS(4)		
Radiated Emissions	EN55032	CLASS B
Conducted Emissions	EN55032	CLASS B
ESD	IEC 61000-4-2	Perf. Criteria A
RS	IEC 61000-4-3	Perf. Criteria A
EFT	IEC 61000-4-4	Perf. Criteria A
Surge	IEC 61000-4-5	Perf. Criteria A
CS	IEC 61000-4-6	Perf. Criteria A
PFMF	IEC 61000-4-8	Perf. Criteria A

ABSOLUTE MAXIMUM RATINGS(5)	
These are stress ratings. Exposure of devices to any of these conditions may adversely affect long-term reliability.	
Input Surge Voltage(100mS)	
5 Models	7 Vdc, max.
12 Models	15 Vdc, max.
24 Models	28 Vdc, max.
Soldering Temperature (1.5mm from case 10sec max.)	260°C, max.

GENERAL SPECIFICATIONS	
Efficiency	See table, typ.
I/O Isolation Voltage(60sec) Input/Output	1000~3000Vdc
I/O Isolation Capacitance	60 pF Typ.
I/O Isolation Resistance	1000M Ω , min.
Switching Frequency	Variable 50kHz
Humidity	95% rel H
Reliability Calculated MTBF(MIL-HDBK-217 F)	>3.5 Mhrs
Safety Standard : (designed to meet)	IEC 60950-1

The information and specifications contained in this data sheet are believed to be correct at time of publication. However, MOTIEN Technologies accepts no responsibility for consequences arising from printing errors or inaccuracies. Specifications are subject to change without notice. No rights under any patent accompany the sale of any such product(s) or information contained herein.

M4 - 1W Regulated Single output

PART NUMBER STRUCTURE

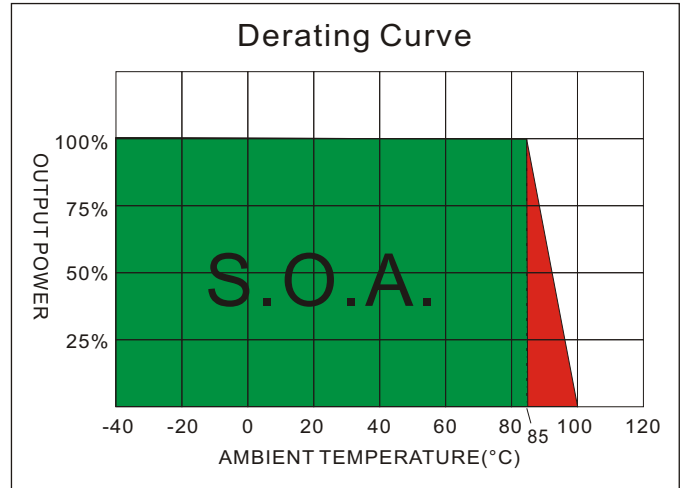
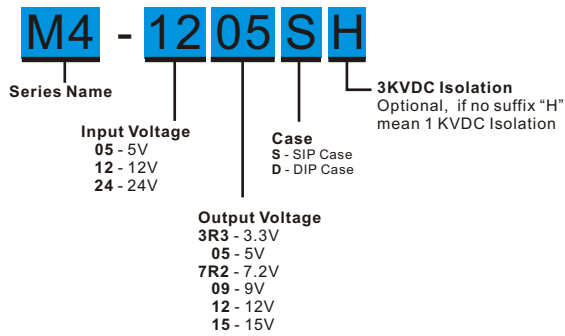

MODEL SELECTION GUIDE

MODEL NUMBER	INPUT Voltage Range (Vdc)	INPUT Current		OUTPUT Voltage (Vdc)	OUTPUT Current Full load (mA)	EFFICIENCY @FL (% , typ.)	Capacitor Load @FL (µF, max.)
		No-Load (mA, max.)	Full Load (mA, typ.)				
M4-053R3S	5	35	351	3.3	303	57	220
M4-0505S	5	30	308	5	200	65	220
M4-057R2S	5	37	299	7.2	139	67	220
M4-0509S	5	30	299	9	111	67	220
M4-0512S	5	36	308	12	83	65	220
M4-0515S	5	47	308	15	67	65	220
M4-123R3S	12	20	137	3.3	303	61	220
M4-1205S	12	20	132	5	200	63	220
M4-127R2S	12	20	126	7.2	139	66	220
M4-1209S	12	22	124	9	111	67	220
M4-1212S	12	22	124	12	83	67	220
M4-1215S	12	20	123	15	67	68	220
M4-243R3S	24	10	68	3.3	303	61	220
M4-2405S	24	10	61	5	200	68	220
M4-247R2S	24	10	61	7.2	139	68	220
M4-2409S	24	10	61	9	111	68	220
M4-2412S	24	10	61	12	83	68	220
M4-2415S	24	12	62	15	67	67	220
M4-053R3D	5	30	351	3.3	303	57	220
M4-0505D	5	35	308	5	200	65	220
M4-057R2D	5	36	294	7.2	139	68	220
M4-0509D	5	30	299	9	111	67	220
M4-0512D	5	35	303	12	83	66	220
M4-0515D	5	48	313	15	67	64	220
M4-123R3D	12	20	139	3.3	303	60	220
M4-1205D	12	20	132	5	200	63	220
M4-127R2D	12	20	126	7.2	139	66	220
M4-1209D	12	22	124	9	111	67	220
M4-1212D	12	25	126	12	83	66	220
M4-1215D	12	20	123	15	67	68	220
M4-243R3D	24	8	66	3.3	303	63	220
M4-2405D	24	10	61	5	200	68	220

Suffix "H" means 3 KVdc isolation

M4 - 1W Regulated Single output

MODEL NUMBER	INPUT Voltage Range (Vdc)	INPUT Current		OUTPUT Voltage (Vdc)	OUTPUT Current Full load (mA)	EFFICIENCY @FL (%. typ.)	Capacitor Load @FL (μF. max.)
		No-Load (mA. max.)	Full Load (mA. typ.)				
M4-247R2D	24	10	61	7.2	139	68	220
M4-2409D	24	10	60	9	111	69	220
M4-2412D	24	10	61	12	83	68	220
M4-2415D	24	11	63	15	67	66	220

Suffix "H" means 3 KVdc isolation

NOTE

1. Ripple/Noise measured with 20MHz bandwidth.
2. Tested by minimal Vin and constant resistive load.
3. Measured Input reflected ripple current with a simulated source inductance of 12μH.
4. Input filter components (C1, L) are used to help meet EMC requirement for the module.
These components should be mounted as close as possible to the module; and all leads should be minimized to decrease radiated noise.
5. Exceeding the absolute ratings of the unit could cause damage. It is not allowed for continuous operating.
6. Operation under no-load conditions will not damage these devices, however they may not meet all listed specifications.

TEST CONFIGURATIONS

EMC Filter

Input filter components (C1, L) are used to help meet conducted emissions requirement for the module. These components should be mounted as close as possible to the module; and all leads should be minimized to decrease radiated noise.

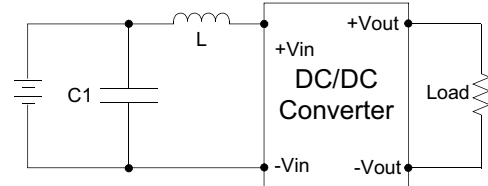

	C1	L
M4-05XXXX	470μF/100V	12μH
M4-12XXXX	470μF/100V	12μH
M4-24XXXX	470μF/100V	12μH

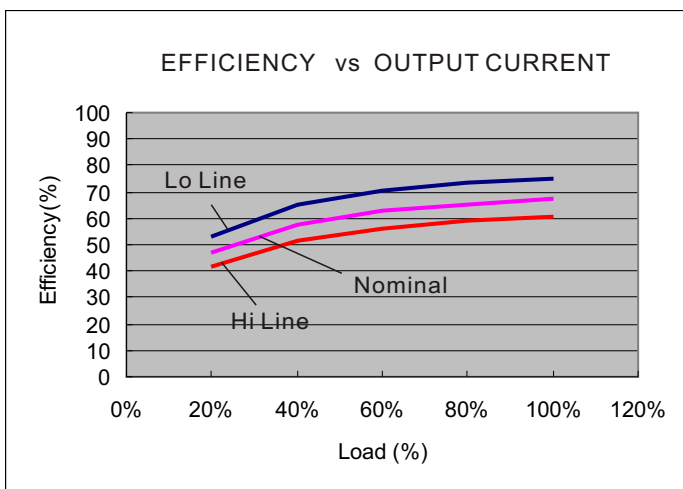

5V Mode

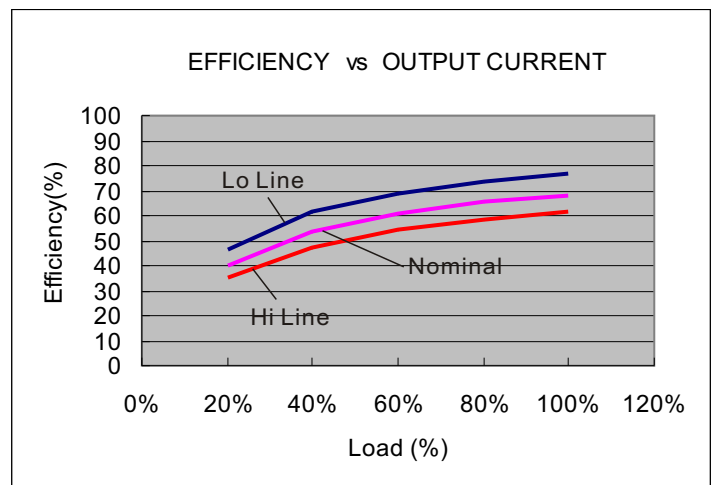

12V Mode

M4 - 1W Regulated Single output

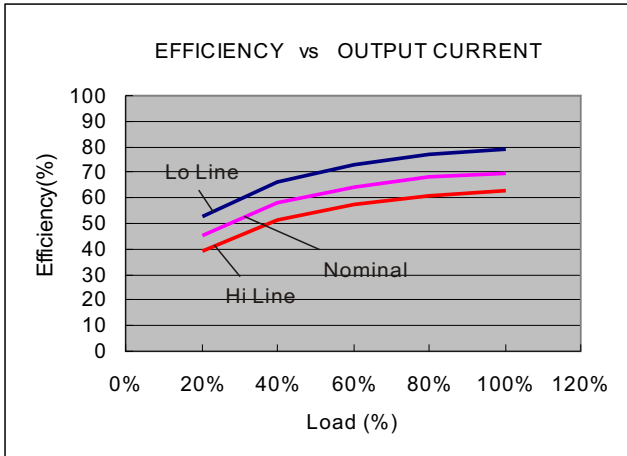

24V Mode

MECHANICAL SPECIFICATIONS

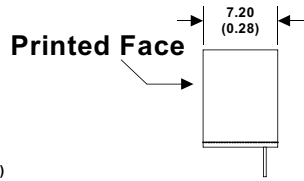
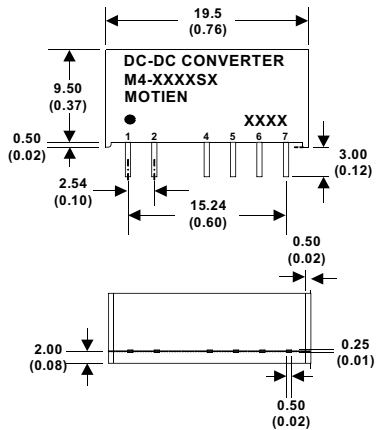

7 Pin SIL Package

- Notes : All dimensions are typical in millimeters (inches).
1. Pin diameter: 0.5 ± 0.05 (0.02 ± 0.002)
 2. Pin pitch and length tolerance: ± 0.35 (± 0.014)
 3. Case Tolerance: ± 0.5 (± 0.02)

PIN CONNECTIONS		
PIN NUMBER	SINGLE	SINGLE-H
1	+V Input	+V Input
2	-V Input	-V Input
4	-V Output	N.P.
5	N.P.	-V Output
6	+V Output	N.P.
7	N.P.	+V Output

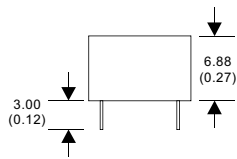
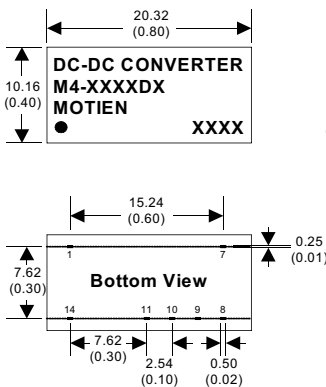

14 Pin DIL Package

- Notes : All dimensions are typical in millimeters (inches).
1. Pin diameter: 0.5 ± 0.05 (0.02 ± 0.002)
 2. Pin pitch and length tolerance: ± 0.35 (± 0.014)
 3. Case Tolerance: ± 0.5 (± 0.02)

PIN CONNECTIONS		
PIN NUMBER	SINGLE	SINGLE-H
1	-V Input	-V Input
7	N.C.	N.C.
8	N.P.	+V Output
9	+V Output	N.P.
10	N.P.	-V Output
11	-V Output	N.P.
14	+V Input	+V Input